

# Earth / Ground Testers

## SATURN GEO / GEO X

### SATURN GEO

- Automatic determination of auxiliary earth electrode- and probe-resistance
- Displays all measuring results for as long as desired
- Programmable LIMITS - optical and acoustical warning at limit infringement
- Long battery service-life because of short-time-measuring method and automatic switch-off
- Operator quick reference on rear of instrument
- Splashproof case IP56 (outdoor application)
- Developed, designed and manufactured as per DIN ISO 9001

### SATURN GEO X

Additionally:

- Measurements with current clamps: Selective, stakeless
- Resistance measurements with 250mA short circuit current
- Output of measured values via interface on printer or PC
- Measuring protocol via PC-software



### Description

At the locations involving the generation, distribution and consumption of electrical energy, certain safety measures must be met in order to protect human life. In many cases, these **safety measures** are national and international regulations which must be checked regularly. **Earthing**, the connection of exposed conductive parts to the earth in case of a fault, represents the most fundamental safety measure. Real life requires the earthing of transformers, high and medium voltage power pylons, railway tracks, tanks, vats, foundations and lightning protection systems. Large fields of applications, the seasonal variations of the earth resistance, variations from weather and ground conditions, require test instrument able to collect and document additional information in order to ensure that the conditions under which the measurement was taken are known and that the results are reproducible. Finally, the device must provide all of this information reliably with the greatest possible simplicity and ease of use.

The **SATURN GEO** and **SATURN GEO X** provide the **perfect solution** by combining the latest technology and years of LEM experience into a compact, field-rugged and extremely easy to use instrument. In addition to performing standard 3- and 4-pole earth resistance measurements, an innovative process accurately measures individual earth electrode resistances in single and meshed earthed systems **without disconnecting any parallel electrodes!** One specific application of this capability is quick and accurate measurement of power pylon grounds. The **SATURN GEO (X)** also incorporates the first truly automatic frequency control (AFC) to minimise interference. Before measuring, the instruments identify existing interference and select a measurement frequency to minimise its effect. The **SATURN GEO (X)** incorporates microprocessor controlled automatic measurements including checking probe hookup to ensure measurements are **taken correctly and measuring** all probe ground resistances to ensure reliable, repeatable results. Probe resistance and auxiliary earth resistance are also measured and displayed. All measured data, as well as the time-of-day the measurement was taken, can be sent to computer or printed via an RS-232C interface.

In real life situations this means:

- **Select function**
- **Press START button**
- **Read measured value**

**SATURN GEO and SATURN GEO X also offer extra features:**

- Earthing resistance 3-pole and 4-pole of 0.001Ω...300kΩ, with voltages of 20 V/48 V AC, with frequencies of 94, 105, 111, 128 Hz or AFC (Automatic Frequency Control), with automatic test of test lead connection and adjustable limit values
- Resistance 2-pole AC 0.001Ω...300 kΩ
- Noise voltage up to 50 V, noise frequency
- Measurement of the earthing impedance of electricity pylons

**SATURN GEO X additionally offers:**

- **Selective measurement of individual earth electrode resistance in interlinked or parallel ground systems (i.e. power pylons, grounding grids, lightning protection systems) without influence from other grounds.**
- Low resistance 2- and 4-pole 0.001 Ω...3 kΩ with automatic polarity reversing and high short-circuit current as per IEC 61557-4
- Display illumination
- Serial interface (RS 232, optional)
- PC-Software WINGEO as an option

## Technical Data

Display:	4-digit (2999), 7-segment-liquid crystal display, 18 mm high, with fluorescent and active illumination (GEO X)
Working temperature:	-10° C ... +50° C
Operating temperature:	0° C ... +35° C
Reference temperature:	+18° C ... +28° C
Storage temperature:	-30° C ...+60° C
Operating error:	refers to operating temperature range
Intrinsic error:	refers to reference temperature range
Climatic class:	JWG as per DIN 40040
Protective type:	IP 56 as per DIN 40050
Operating altitude:	max. 2000 m
Safety:	Safety class II (□) as per IEC/EN 61010-1
Max. noise voltage:	24 V, thereon measurements are locked
Power supply:	6 x 1.5 V alkali-mangan batteries (IEC LR 6) or 1.5 V zink-carbon-batteries (IEC R 6) or 1,2 V accus
Dimensions:	240 x 180 x 110 mm (L x W x H)
Weight:	approx. 1.5 kg incl. batteries approx. 5.9 kg incl. 4 pcs. batteries and accessories in carrying case
Warranty:	2 years
Calibration interval:	3 years, recommended

## SATURN GEO

### Noise voltage (DC + AC) (UST)

Measuring method: mean value rectification

measuring range	display range	resolution	frequency range	intrinsic error
1 ... 50 V	0.0 ... 50 V	0.1 V	DC/AC 45...400Hz sine	±(5 % of MV + 5D)

Measuring rate: approx. 4 measurements/s  
Internal resistance: approx. 1.5 MΩ  
Max. overload: U<sub>eff</sub> = 250 V

### Interference frequency (FST)

Measuring method: measurement of period of noise voltage

measuring range	display range	resolution	v-range	operating error
16...400 Hz	16.0...300...999	0.1...1Hz	1V... 50 V	±(1 % of MV + 2D)

### Earthing resistance RA (RE) as per IEC 61557-5:

Measuring method: Current and voltage measurement with probe  
Measuring voltage: 20/48 V AC - switchable  
Short circuit current: 250 mA  
Measuring frequency: 94/105/111/128 Hz manual or autom. (AFC) switchable, 55 Hz for R\*  
Max. overload: U<sub>eff</sub> = 250 V

switch position	measuring range	resolution	intrinsic error	operating error
RA 3pole 4pole	0.020Ω...300kΩ	0.001...100Ω	±(2 % of MV + 2D)	±(5 % of MV + 5D)

Automatic range selection

Measuring time: typ. 8 sec. with fixed frequency chosen  
max. 30 sec. with autom. frequency selection

Max. probe resistance: <1 MΩ  
Max. auxiliary earth res.: <1 MΩ

Display shows warning R<sub>s</sub> resp. R<sub>H</sub>, if ratio R<sub>H</sub>/R<sub>E</sub> is too high

Max. noise voltage: 24 V, above no measurement is started  
Noise voltage suppr.: 120dB (16<sup>2/3</sup>, 50, 60, 400 Hz)

### Resistance (R~):

Measuring method: 2-pole current and voltage measurement  
Measuring voltage: 20 V AC  
Short circuit current: 250 mA AC  
Measuring frequency: 94/105/111/128 manual or autom. (AFC)

switch position	measuring range	resolution	intrinsic error	operating error
RA 2pole	0.020Ω...300kΩ	0.001...100Ω	±(2 % of MV + 2D)	±(5 % of MV + 5D)

Measuring time: typ. 6 sec.  
Max. noise voltage: 24 V, above no measurements started  
Max. overload: U<sub>eff</sub> = 250 V

### R\* - earthing impedance with 55 Hz

For calculation of short circuit current in power distribution systems

## SATURN GEO X:

### Noise voltage (DC + AC) (UST)

Measuring method: mean value rectification

measuring range	display range	resolution	frequency range	intrinsic error
1 ... 50 V	0.0 ... 50 V	0.1 V	DC/AC 45...400Hz sine	±(5% of MV + 5D)

Measuring rate: approx. 4 measurements/s  
Internal resistance: approx. 1.5 MΩ  
Max. overload: U<sub>eff</sub> = 250 V

### Interference frequency (FST)

Measuring method: measurement of period of noise voltage

measuring range	display range	resolution	voltage range	operating error
16...400Hz	16.0...300...999 Hz	0,1...1Hz	1V... 50 V	±(1 % of MV + 2D)

### Earthing resistance RA (RE) as per IEC 61557-5:

Measuring method: current and voltage measurement with probe  
Measuring voltage: 20/48 V AC switchable  
Short circuit current: 250 mA  
Measuring frequency: 94/105/111/128 Hz manual or autom. (AFC) switchable, 55 Hz for R\*  
Max. overload: U<sub>eff</sub> = 250 V

switch position	measuring range	resolution	intrinsic error	operating error
RA 3pole 4pole	0.020Ω...300kΩ	0.001...100Ω	±(2 % of MV + 2D)	±(5 % of MV + 5D)

automatic range selection

Measuring time: typ. 8 sec. with fixed frequency chosen  
max. 30 sec. with autom. frequency selection

Max. probe resistance: <1 MΩ  
Max. auxiliary earth electrode resistance: <1 MΩ

Display shows warning R<sub>s</sub> resp. R<sub>H</sub>, if ratio R<sub>H</sub>/R<sub>E</sub> is too high  
Max. noise voltage: 24 V, above no measurement is started  
Noise voltage suppr.: 120dB (16<sup>2/3</sup>, 50, 60, 400 Hz)

### Selective earthing resistance (RA ):

with supplementary current transformer

switch position	measuring range	resolution	intrinsic error	operating error
RA 3-pole 4-pole 	0.020Ω...30kΩ	0.001...10Ω	±(7 % of MV + 2D)	±(10 % of MV + 5D)

Transformer ratio: 80...1200 : 1, (adjustable)

Minimal current in single

branch to be measured: 0,5 mA with transformer 1000:1  
0,05 mA with transformer 100:1

Intrinsic error: operating error (RA) + error (clamp)  
Other data see earthing resistance ( RA )

### Resistance (R ~ ) as per IEC 61557-4:

Measuring method: current and voltage measurements 2-pole and 4-pole method possible

Open-circuit voltage: 20 V DC  
Short circuit voltage: 250 mA DC

switch position	measuring range	resolution	intrinsic error	operating error
RA ~ 2-pole 4-pole	0.020Ω...3kΩ	0.001...1Ω	+(2 % of MV + 2D)	+(5 % of MV + 5D)

Measuring time: approx. 4 sec. with reversing of polarity  
Max. noise voltage: <3 V AC/DC, above no measurement started  
Max. inductivity: 2 Henry  
Max. overload: U<sub>eff</sub> = 250 V

### Resistance (R~)

Measuring method: 2-pole current and voltage measurement  
Measuring voltage: 20 V AC  
Short circuit current: 250 mA AC  
Measuring frequency: 94/105/111/128 man./autom. (AFC) switchable

switch position	measuring range	resolution	intrinsic error	operating error
RA 2-pole	0.020Ω...300kΩ	0.001...100Ω	+(2 % of MV + 2D)	+(5 % of MV + 5D)

Measuring time: typ. 6 sec.  
Max. noise voltage: 24 V, above no measurement will be started  
Max. overload: U<sub>eff</sub> = 250 V

### R\* - earthing impedance with 55 Hz

For calculation of short circuit current in power distribution systems

# Applications

## Principle of measurement:

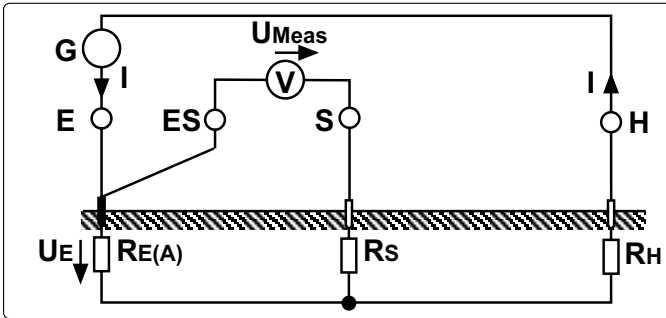

## Practical test measuring setup:

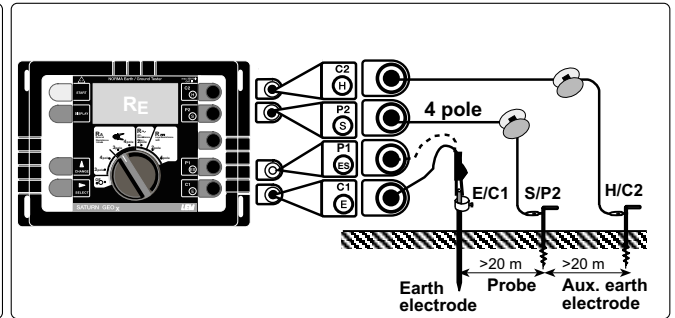

## 3 pole- and 4 pole-measurements:

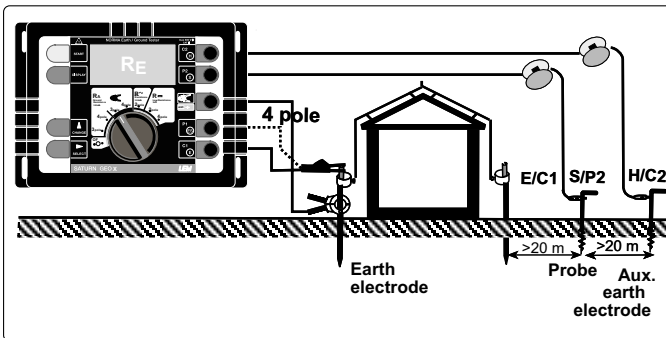

## Earth resistance measurement at high voltage pylons:

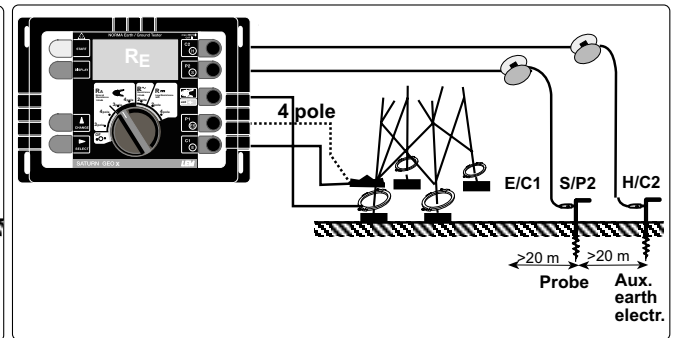

## Specific earth resistance according to Wenner:

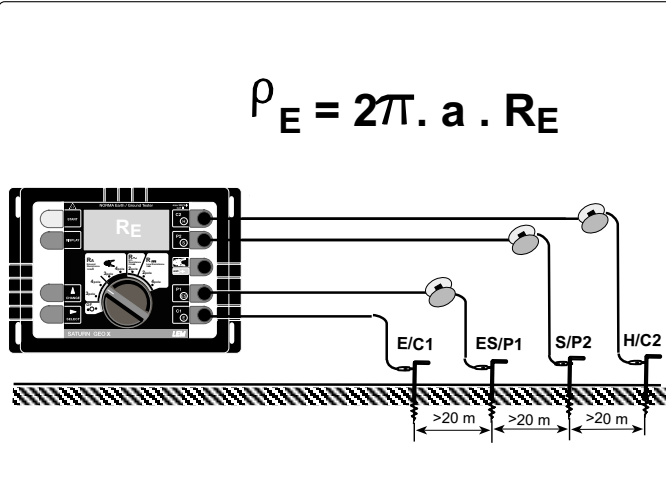

## Selective measurement at high voltage pylons:

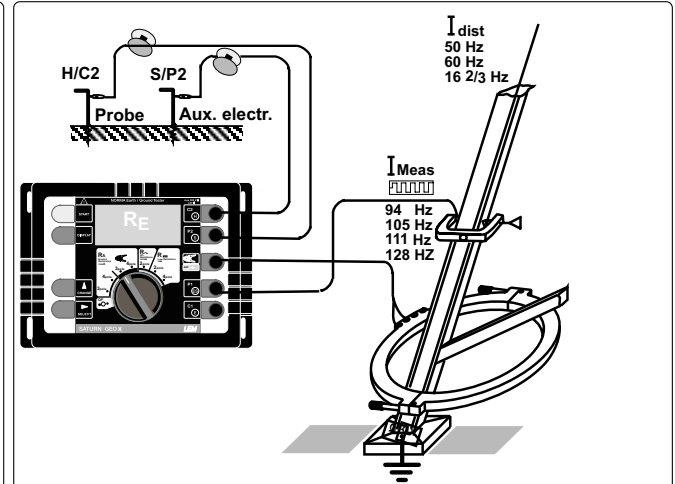

## Stakeless measurement of earth loops:

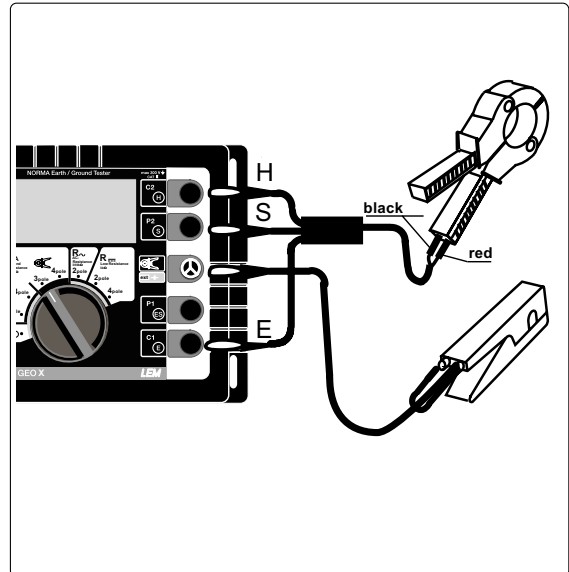
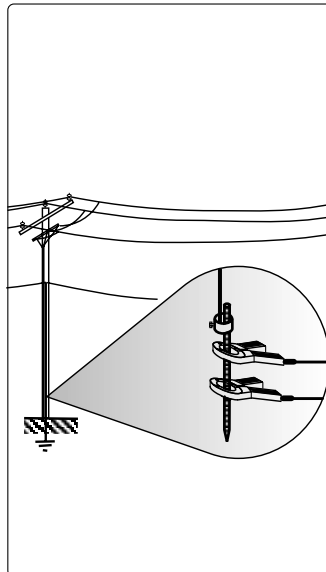
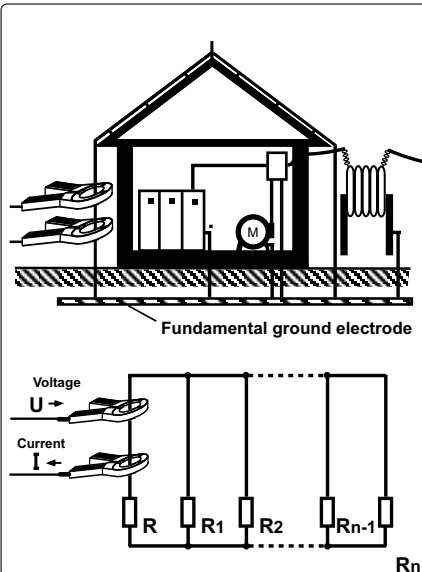

# SATURN GEO X + WIN GEO -

- the professional system for earth measurements

The image displays the Saturn GEO X system, which includes a handheld device and a PC software interface. The software interface shows various measurement parameters and settings, such as date, time, and test results. A printed form is also shown, detailing the measured values for different earth parameters.

Measured values:		Re 4pole
Re		80.5 Ohm
Fm		111 Hz
Rh		1 kOhm
Rs		2 kOhm

## Functions WIN GEO:

- Data acquisition from SATURN GEO X (support of all measuring functions)
- Data export of measured data (ASCII) to Windows® applications (Winword®, Excel®, Access®)
- Measurement protocols - the values are transferred automatically (DDE) to forms of Windows® applications
- Remote control of SATURN GEO X - selection and initiation of measuring functions, downloading measurement values
- SETUP - Setting of date/time, input of user defined text
- DIAGNOSE - display/print settings of SATURN GEO X

## RS232 Interface (option):

### Electrical data:

- voltage levels according to EIA RS 232C specifications
- parameters: 2400 Baud, 8 data bits, no parity, 1 stop bit
- half duplex
- lines: GND; TXD; RXD; RTS
- Test voltage: 3 kV AC
- nonvolatile memory for 48 characters of user defined text (incl. control characters <CR>, <LF>)

### Software

- setup/diagnose software on 3 1/2 inch disk, 1.44 MB, for all PCs higher than DOS 3.3

<b>Order Codes</b>	
<b>Description</b>	<b>Order-No.</b>
<b>SATURN GEO Basic Set</b> SATURN GEO incl. rubber protective cover 2 measuring leads 1.5 m long 2 alligator clips 1 carrying strap 6 batteries Manual in English, German or French	A 1885 06411
<b>SATURN GEO X Basic Set</b> SATURN GEO X incl. rubber protective cover 2 measuring leads 1.5 m long with test tips 2 crocodile clips 1 carrying strap 6 batteries Manual in English, German or French	A 1885 06510
<b>SATURN GEO X with GEO measuring set 4pole</b> same as A 1885 06510 and additionally: 4 earth stakes 3 reels with 2x25m and 1x50m wire delivered in carrying case	A 1885 06511
<b>SATURN GEO X with interface and GEO measuring set 4pole</b> same as A 1885 06511 additionally: 1 interface RS232 1 Set-up Software 1 RS232 cable and PC adapter	A 1885 06512
<b>Accessories</b>	
<b>GEO-measuring set 3-pole</b> 2 earth stakes, 1 reel with 25m wire 1 reel with 50m wire	A 6045 10302
<b>GEO-measuring set 4-pole</b> 4 earth stakes, 2 reels with 25m wire, 1 reel with 50m wire	A 6045 10301
<b>GEO-Clamp set "selective"</b> for selective measurements 1 clamp 100A, 1 connector clamp cable	A 6045 10305
<b>GEO-Clamp set "stakeless"</b> for stakeless earth resistance measurements 1 clamp 100A, 1 clamp 1000A 1 clamp connector cable 1 adapter for stakeless measurements 1 manual	A 6045 10306

<b>Description</b>	<b>Order-No.</b>
<b>Carrying case</b> for SATURN GEO / GEO X and accessories	A 6030 00530
<b>PC-software WINGEO for SATURN GEO X</b> Windows software for setup of SATURN GEO X, diagnosis, data acquisition, protocol generation, operating instructions, 3 1/2 " disk	A 6899 00172
<b>Current transformer 1000A</b> , opening up to 54 mm, for selective earth resistance measurements	A 6805 01010
<b>Current transformer 100A</b> , opening up to 12 mm, for selective earth resistance measurements	A 6805 01007
<b>Adapter for stakeless earth measurements</b> (2 clamps necessary)	A 6403 06311
<b>Split-core current transformer</b> for measurements on high voltage pylons up to 310 mm	A 6805 06211
<b>Accumulator set 1500 mAh</b> 1,5 Ah NiCd-Accu, electronics, mains adapter	A 6403 04111
<b>Accumulator set 600 mAh</b> 0,6 Ah NiCd-Accu, electronics, mains adapter, cable for 12 V car system, manual. Versions GB for UK, US for USA	A 6403 06211
<b>Earth stake 35 cm</b>	A 6045 10350
<b>Reel with 25 m cable</b>	A 6045 05102
<b>Reel with 50 m cable</b>	A 6045 05103
<b>3 alligator clips</b>	A 6009 17103
<b>3 test tips</b>	A 6009 54300
<b>Interface RS 232 for GEO X</b> for data transfer to printer or PC incl. 3 1/2" disk with setup + diagnose software, cable for PC, manual	A 6412 06211
<b>Thermoprinter DPU 201 for SATURN GEO X</b> with interface, data printing via RS232	A 6413 06111
<b>Paper for printer DPU 201</b>	A 6202 46111
<b>Adapter RS232-CENTRONICS</b> adapter, cable for direct printing from RS232 interface on CENTRONICS printers	A 6045 00610